

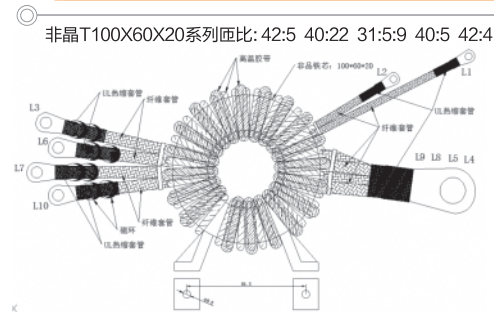

## 非晶变压器系列 Amorphous Transformers Series



丝包线 非晶 T100X60X20



## 非晶变压器系列 Amorphous Transformers Series



多股线 非晶 T 100X60X20

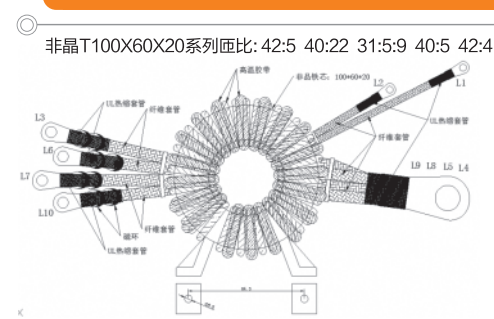

## 非晶变压器系列 Amorphous Transformers Series



非晶 T105X60X30

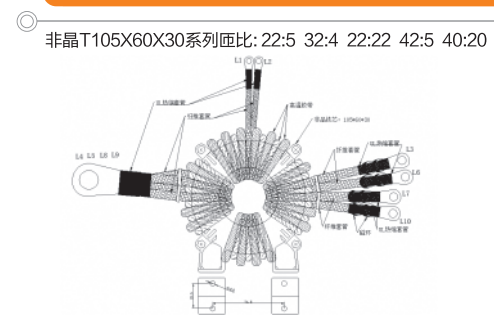

## 非晶变压器系列 Amorphous Transformers Series

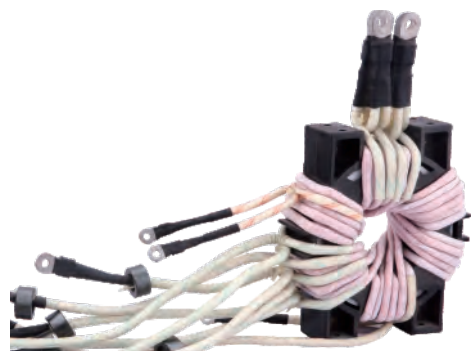

非晶 T130X80X40

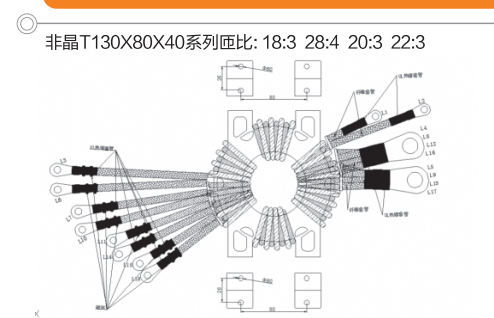

## 非晶变压器系列 Amorphous Transformers Series



非晶 T80X50X25 T70X40X25 T64X40X20

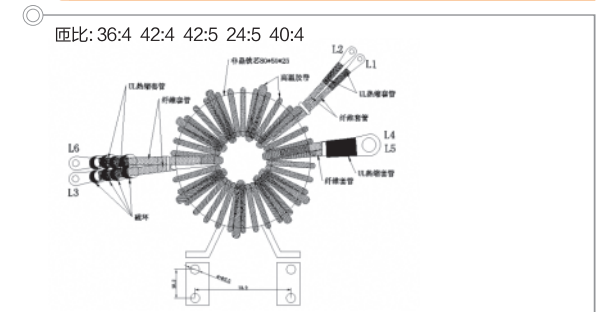

## 非晶变压器系列 Amorphous Transformers Series



非晶 T120X60X30 T120X70X20 T120X70X25

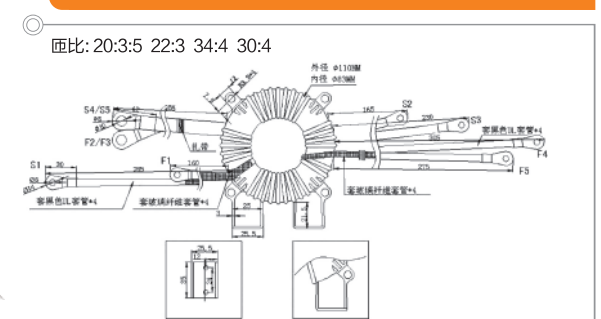

## 非晶变压器系列 Amorphous Transformers Series



非晶 T50X32X20 T64X40X20  
T55X37X30 T40X25X20

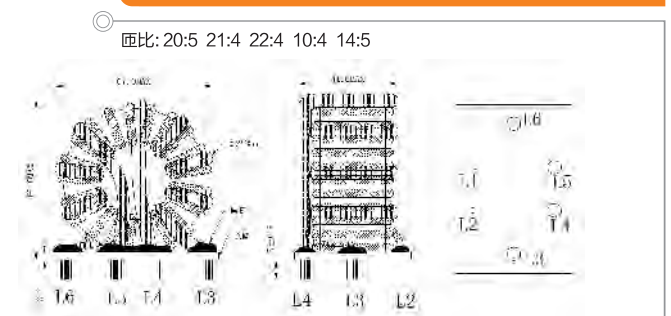

## 非晶变压器系列 Amorphous Transformers Series



铁氧体 T56X28X28 T63X38X25 T63X35X30

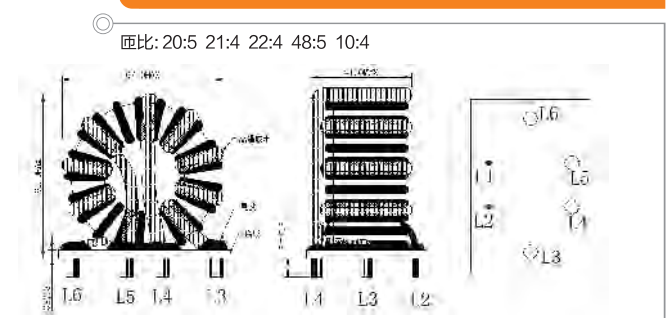



ETD-49

### 逆变变压器系列 Inverse Transformers Series

ETD-49系列匝比: 8:4 9:3 9:4 9:9 10:5 11:4 11:5  
 13:4 20:4 22:3 22:4 28:5等

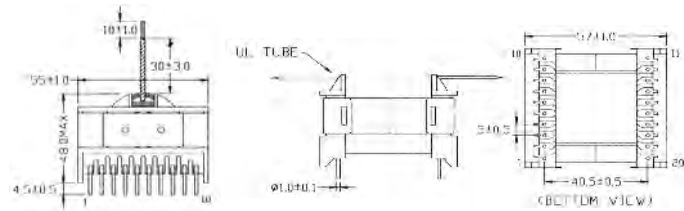

### 逆变变压器系列 Inverse Transformers Series

EE-85系列匝比: 15:5 16:5等

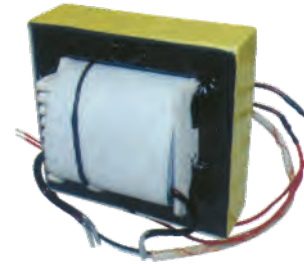

EE-85

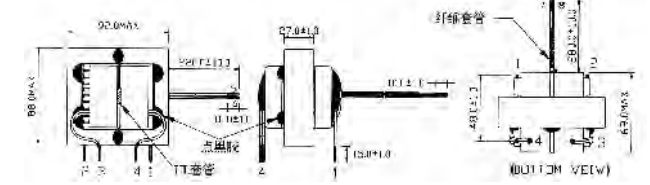

ETD-49

### 逆变变压器系列 Inverse Transformers Series

ETD-49系列匝比: 8:4 9:3 9:4 9:9 10:5 11:4 11:5 13:4 20:4  
 22:3 22:4 28:5等

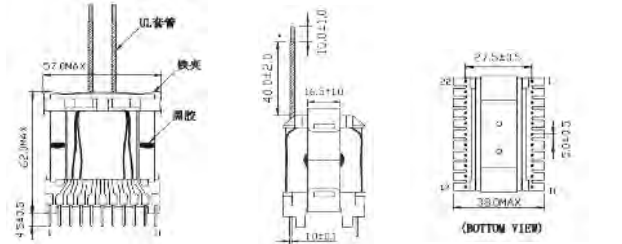

### 逆变变压器系列 Inverse Transformers Series

EER-43X15系列匝比: 10:9 22:10 23:11 24:9等



EER-43X15

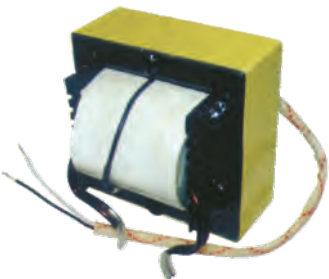
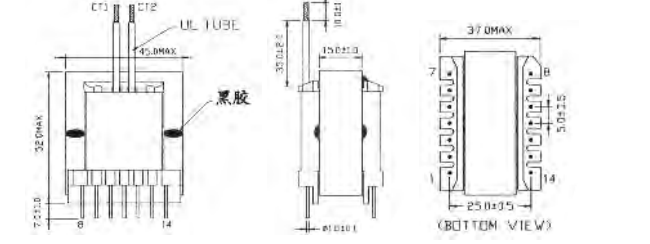

EE-65

### 逆变变压器系列 Inverse Transformers Series

EE-65系列匝比: 15:5 16:5等

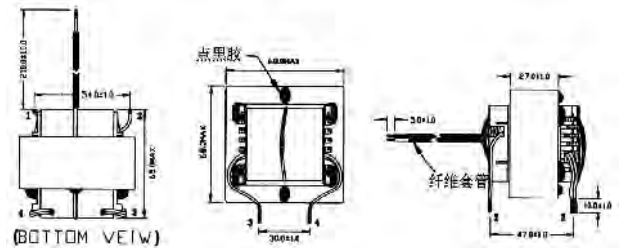

### 逆变变压器系列 Inverse Transformers Series

EER-43X15系列匝比: 9:4 10:4 10:5 10:9 12:4 13:4  
 13:5 15:4 20:4 22:3 22:4 22:9 24:9 25:15等



EER-43X15

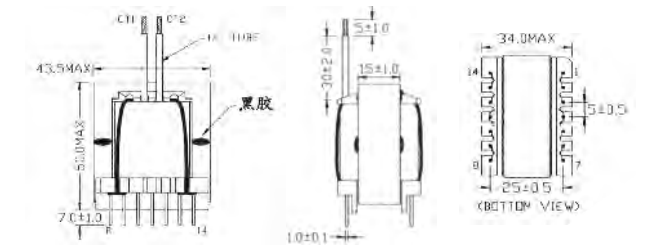

EE-70

### 逆变变压器系列 Inverse Transformers Series

EE-70系列匝比: 15:5 16:5等

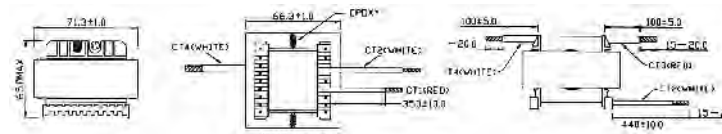

### 升压变压器系列 Step-up Transformers Series

ERL-35系列匝比: 43:100 43:127 43:130 43:160  
 47:100 52:100 55:100 75:160等



ERL-35

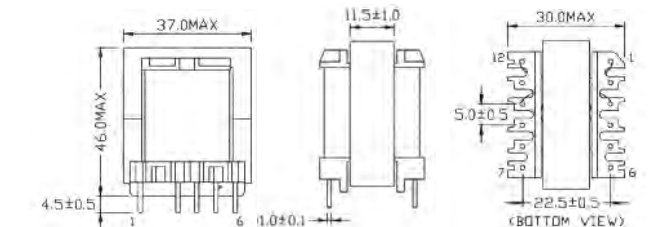

## 电抗器系列 Electric Reactors Serie



EI-96X40

EI-96X40系列匝比: 8TS等

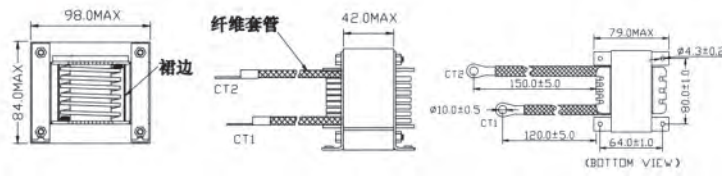

## 电抗器系列 Electric Reactors Serie



铁氧体56-28-28

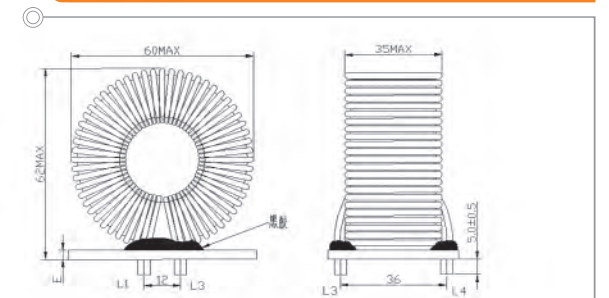

## 电抗器系列 Electric Reactors Serie



EI-96X40

EI-96系列匝比: 8.5TS 9.5TS等

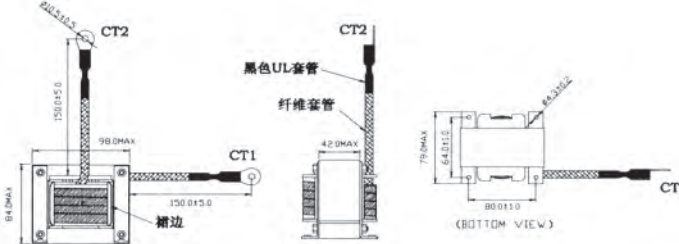

## 电抗器系列 Electric Reactors Serie



T184

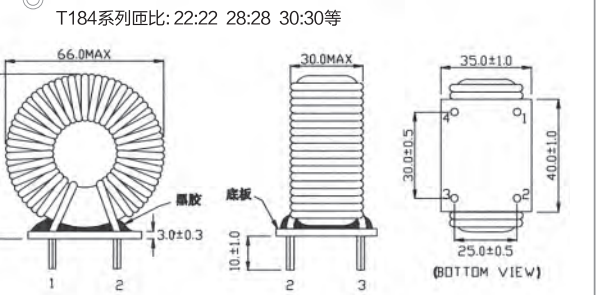

## 电抗器系列 Electric Reactors Serie



EI-96X40

EI-96系列匝比: 8.5TS 9.5TS等

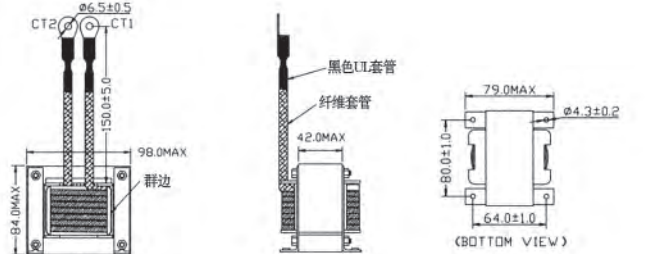

## 电抗器系列 Electric Reactors Serie



T184

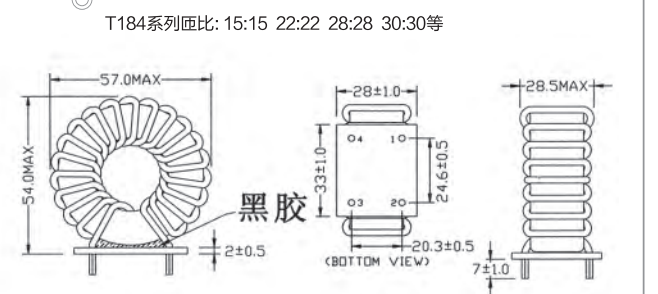

## 电抗器系列 Electric Reactors Serie



EI-96

EI-96系列匝比: 8.5TS 9.5TS等

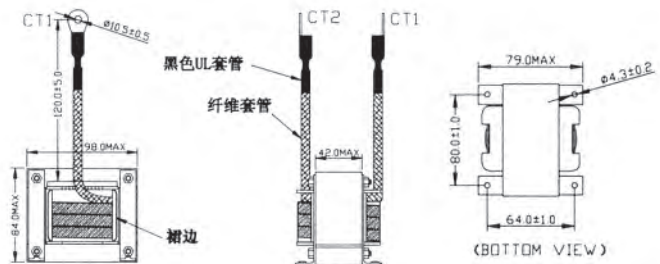

## 电抗器系列 Electric Reactors Serie



T250-26

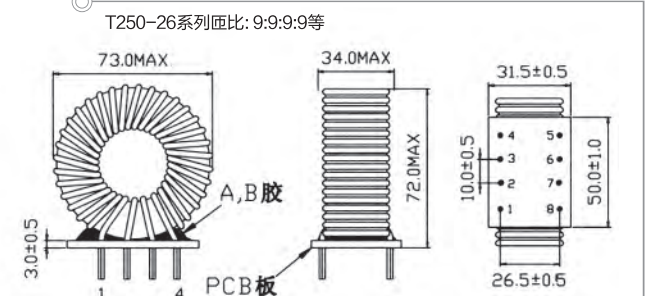

### 电抗器系列 Electric Reactors Serie



Φ 30X702P

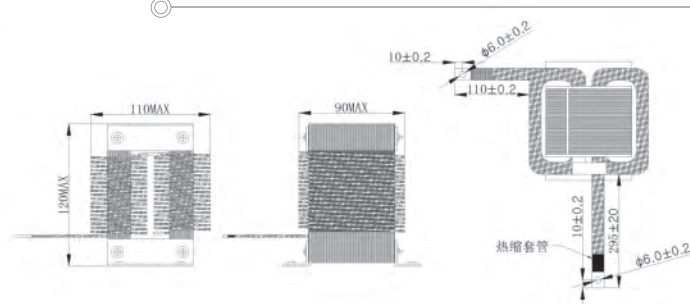

### 电抗器系列 Electric Reactors Serie

Φ60X25X4系列匝比: 15TS



Φ60X25X4

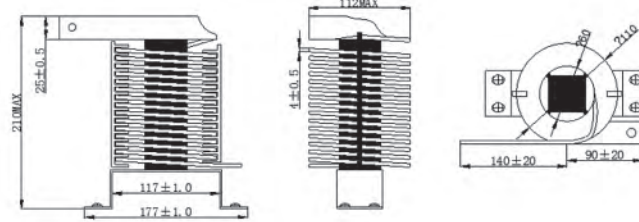

### 电抗器系列 Electric Reactors Serie

Φ47X15X4系列匝比: 14TS



Φ47X15X4

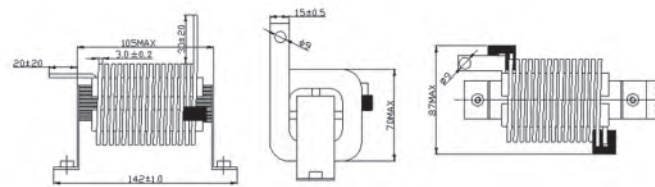

### 大功率变压器系列 Super power Transformers Series

UF-70系列匝比:26:4 28:4 32:4



UF-70

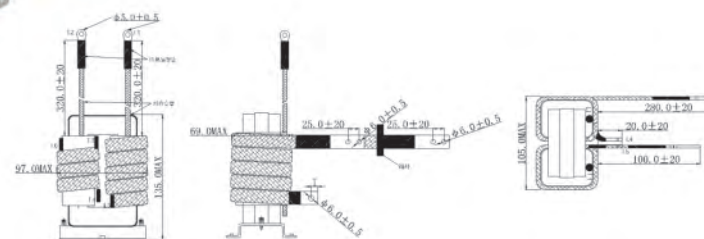

### 低频变压器系列 Low Frequency Transformers Series



EI-28X15

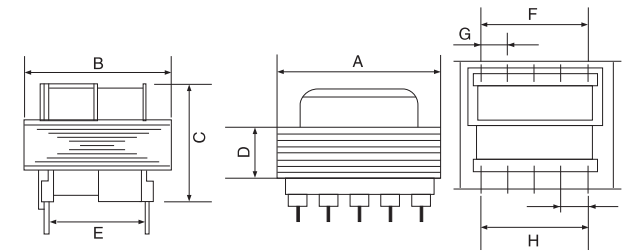

### 低频变压器系列 Low Frequency Transformers Series



EI-86X30

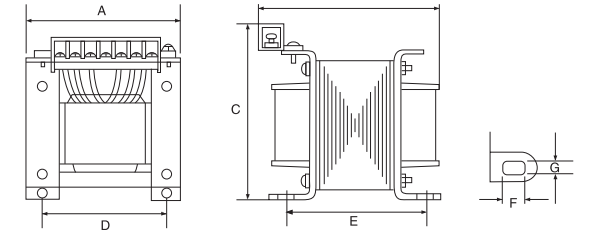

### 低频变压器系列 Low Frequency Transformers Series



EI-57X25

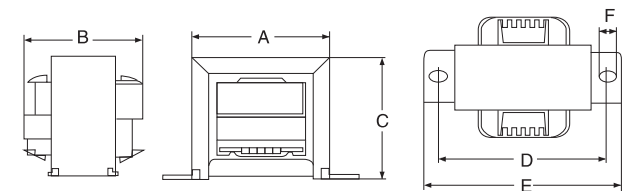

### 低频变压器系列 Low Frequency Transformers Series

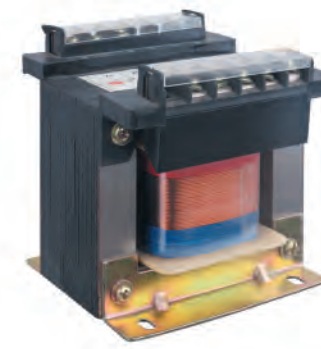

EI-114X50

